

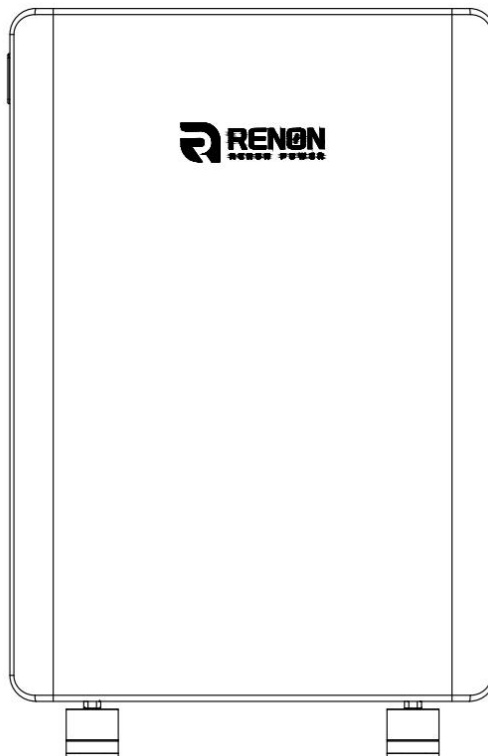

# User Manual of Xcellent Plus

## (R-XC016161 / R-XC016161-H)



Email: [support@renonpower.com](mailto:support@renonpower.com)

Official website: [www.renonpower.com](http://www.renonpower.com)

Address: 5900 Balcones Drive STE 100, Austin, TX 78731, United States



## Revision History

Ver.	Date	Revise contents	Reviser
A00	2024.09.11	New Edition	Janice
A01	2024.10.14	<ol style="list-style-type: none"> <li>1. Change the installation picture of location and horn ring.</li> <li>2. Change the horn ring to Universal Wheel and Directional Wheel,and modify it installation describe.</li> <li>3. Modify the footed glass Specification.</li> <li>4. Added the description of FUN.SET dial code.</li> <li>5. Delete the inverter dial code of GOODWE.</li> <li>6. Added the description of protective ring.</li> <li>7. Modify the code of Investigation &amp; troubleshooting related protection and release temp.</li> <li>8. Change the horn ring to trundle.</li> <li>9. Change the temp of discharge and charge high temp protection.</li> </ol>	Janice
A02	2024.11.05	Modify the inverter dial code of Solis.	Janice



# Catalogue

1	Safety Instructions .....	5
1.1	General Safety Precautions .....	5
1.2	Transportation and Storage Precautions .....	6
1.3	Installation Precautions .....	6
1.4	Usage Precautions .....	7
1.5	Response to Emergency Situations .....	8
1.6	Qualified Personnel .....	8
2	Introduction .....	10
2.1	Product features .....	10
2.2	Specifications .....	11
2.3	Light And Button .....	12
2.3.1	Light .....	12
2.3.2	Button .....	13
2.4	Interface Information .....	14
2.4.1	On/Off .....	14
2.4.2	Link-in Parallel Communication Port .....	15
2.4.3	Link-out Parallel Communication Port .....	15
2.4.4	Inverter Communication Port (RJ45) .....	16
2.4.5	Debug Port .....	16
2.4.6	Inverter Dial Switch .....	17
2.4.7	Function Dial Switch .....	19
2.4.8	Address Dial Switch .....	19
2.4.9	Debug Port (connector) .....	20
2.4.10	Inverter Communication Port (connector) .....	20
2.4.11	Dry Contact & GPIO Port .....	21
2.4.12	Power Positive .....	21
2.4.13	Power Negative .....	21
3	Installation and Usage .....	22
3.1	Safe Handling Guide .....	22
3.1.1	Familiar with the product .....	22
3.1.2	Precautions before installation .....	22
3.1.3	Tools .....	22
3.1.4	Safety gear .....	22



---

3.2 System Premeasurement .....	23
3.3 Installation location .....	23
3.4 Package items .....	24
3.5 Installation .....	25
3.6 Connection of Cable and Power .....	29
3.7 Wi-Fi Configuration .....	32
3.8 Parallel connection (Optional) .....	40
4 Troubleshooting & Maintenance .....	41
4.1 Regular maintenance .....	41
4.2 Troubleshooting .....	41
4.3 Alarm Codes .....	43
4.4 Error Codes .....	45
4.5 Protection Codes .....	46



# 1 Safety Instructions

Safety Instructions for safety reasons, installer and user are responsible for familiarizing themselves with the contents of this document and all warnings before installation and usage.

## 1.1 General Safety Precautions

- Please carefully read this manual before any work is carried out on the product, and keep it located near the product for future reference.
- All installation and operation must comply with local electrical standards.
- Please ensure the electrical parameters of the product are compatible to related equipment.
- Do not open or dismantle the battery module. Electrolyte is very corrosive. In normal working conditions contact with the electrolyte is impossible. If the battery casing is damaged, do not touch the exposed electrolyte or powder because it is corrosive.
- The electronics inside the product are vulnerable to electrostatic discharge, keep it away from that.
- Do not place items or tools on the product.
- Do not damage the product by dropping, deforming, impacting, cutting.
- Keep the product away from liquid. Do not touch the product if liquid spills on it. There is a risk of electric shock.
- Do not expose the product to flammable or harsh chemicals or vapors.
- Do not paint any part of the product, include any internal or external components.
- Do not change any part of the product, especially the battery and cell.
- Besides connection under this manual, any other foreign object is prohibited to insert into any part of the product.
- The warranty claims are excluded for direct or indirect damage due to items above.
- Batteries must not be mixed with domestic or industrial waste.



- Batteries marked with the recycling symbol must be processed via a recognized recycling agency. By agreement, they may be returned to the manufacturer.

## **1.2 Transportation and Storage Precautions**

- The batteries must be transported according to UN3480, they must be packed according to packaging requirements of Special Regulation 230 of IMDG CODE (40-20 Edition) for maritime transport, and P965 IA for air transport (SOC less than 30%). The original packaging complies with these instructions.
- If the product needs to be moved or repaired, the power must be cut off and completely shut down.
- The product must be transported in its original or equivalent package; the battery module must be placed at upright position.
- The modules are heavy. Ensure adequate and secure mounting and always use suitable handling equipment for transportation.
- If the product is in its package, use soft slings to avoid damage.
- Do not stand below the product when it is hoisted.
- During transportation, severe impact, extrusion, direct sunlight, and rain should be avoided.
- Store in a cool and dry place.
- Store the product in clean environment, free of dust, dirt and debris.
- Store the product out of reach of children and animals.
- Don't store the battery under 50% SOC for over one month, this may result in permanent damage to the battery and void the warranty.
- If the product is stored for long time, it is required to charge the battery module every 3 months, and the SOC should be no less than 90%.

## **1.3 Installation Precautions**

- Do not install the product in an airtight enclosure or in an area without ventilation.
- Do not install the product in living area of dwelling units or in sleeping units



other than within utility closets and storage or utility spaces.

- If the Product is installed in a garage or carport, ensure there is adequate clearance from vehicles.
- While working on the product wear protective eyeglasses and clothing.
- Handle the battery wearing insulated gloves.
- Use insulated tools. Do not wear any metallic items such as watches, bracelets, etc.
- Please turn-off related circuit breakers before and during the installation to avoid electric shock.
- Do not connect any AC conductors or photovoltaic conductors directly to the battery pack. These are only to be connected to the inverter.
- Wiring must be correct, do not mistake the positive and negative cables, and ensure no short circuit with the external device.
- Over-voltages or wrong wiring could damage the battery pack and cause combustion which can be extremely dangerous.
- Make sure the product is well grounded, and comply with local specifications, the recommended grounding resistance is less than  $1\Omega$ .
- Handle with care because Li-ion Battery is sensitive to mechanical shock.

## **1.4 Usage Precautions**

- Before starting the system, the operator should strictly check the connection terminals to ensure that the terminals are firmly connected.
- If there's a circuit breaker between battery and inverter, the breaker is supposed to be on before power on the battery.
- Do not open the product, connect, or disconnect any wires when it's working to avoid electric shock.
- Battery needs to be recharged within 12 hours after fully discharged.
- The default temperature range over which the battery can be discharged is  $-4^{\circ}\text{F}$  ( $-20^{\circ}\text{C}$ ) to  $131^{\circ}\text{F}$  ( $55^{\circ}\text{C}$ ). Frequently discharge the battery in high or low temperature may deteriorate the performance and life of the battery pack.



- The default temperature range over which the battery can be charged is 32°F (0°C) to 131°F (55°C). Frequently charge the battery in high or low temperature may deteriorate the performance and life of the battery pack.
- Do not charge or discharge a damaged battery.
- Please contact the supplier within 24 hours if there is something abnormal.

## **1.5 Response to Emergency Situations**

- Damaged batteries are dangerous and must be handled with extreme care. They are not suitable for use and may cause danger to persons or property. If the battery pack appears to be damaged, place it in the original container and return it to an authorized dealer.
- If the battery pack is wet or submerged in water, do not allow any person access, and then contact authorized dealer for technical support.
- In case of fire, use the carbon dioxide, FM-200 or ABC dry powder fire extinguisher; if possible, move the battery pack to a safe area before it catches fire.
- If a user happens to be exposed to the internal materials of the battery cell due to damage on the outer casing, the following actions are recommended.
- In case of inhalation: Leave the contaminated area immediately and seek medical attention.
- In case of contact with eyes: Rinse eyes with running water for 15 minutes and seek medical attention.
- In case of contact with skin: Wash the contacted area with soap thoroughly and seek medical attention.
- In case of ingestion: Induce vomiting and seek medical attention.

## **1.6 Qualified Personnel**

The installation guide part described herein is intended for use by skilled staff only. A skilled staff is defined as a trained and qualified electrician or installer who has all the following skills and experience:

- Knowledge of battery' specification and properties.





- 
- Knowledge of the installation of electrical devices.
  - Knowledge of torsion and screwdrivers for different types of screws.
  - Knowledge of local installation standards.
  - Electrical license for battery installation required by the country or state.
  - Knowledge of the dangers and risks associated with installing and using electrical devices and acceptable mitigation methods.
  - Knowledge of and adherence to this guide and all safety precautions and best practices.

For safety reasons, installers are responsible for familiarizing themselves with the contents of this document and all warnings before performing installation and usage.



## 2 Introduction

The Xcellent Plus is a lithium iron phosphate battery-based energy storage product developed and produced by RENON, it can supply reliable power for nearly all kinds of household appliances and equipment.

The Xcellent Plus consists of a built-in BMS battery management system, which can manage and monitor cells information including voltage, current and temperature, used to limit the balance current between different batteries when parallel use to expand capacity and power to meet the requirements of longer power supporting duration and higher power consumption.

The Xcellent Plus is good looking. It is suspended on the wall in daily usage.

### 2.1 Product features

- With a DC-DC converter inside, users can extend or change battery modules whenever they want, no need to consider the quality or SOC of old modules;
- The whole product is non-toxic, pollution-free and environment-friendly;
- Cathode material is made from LiFePO<sub>4</sub> with safety performance and long cycle life;
- Small volume, light weight, plug-in embedded design module, easy to install and maintain;
- Working temperature range is from -4 °F to 122 °F (-20 °C to 50 °C) with excellent discharge performance and cycle life;
- Battery management system (BMS) has protection functions including over-discharge, over-charge, and over-current and high/low temperature;
- The battery has less self-discharge, up to 3 months without charging it on shelf, no memory effect, excellent performance of shallow charge and discharge;
- The system can automatically manage battery charge and discharge state; and save energy cost by various control strategy.



## 2.2 Specifications

Item	R-XC016161 / R-XC016161-H
Battery Chemistry	LiFePO4
Nominal Energy (kWh)	16
Nominal Capacity (Ah)	314
Max. Charging/Discharging Current (A)	190
Nominal Voltage (V)	51.2
Recommend Charging Voltage (V)	56.8
Max. Charging Voltage (V)	58.4
Discharge Cut-off Voltage (V)	43.2
Heating Power(W)	100
Heating Start Temperature (°F/°C)	41/5 (-H model only)
Operation Temperature(°F/°C)	Discharge: -4~131 / -20~55 Charge: 32~131 / 0~55
Safety Function	Over-charge, Over-discharge, Over-current, Low/High-temperature, Short-circuit Protections
Parallel Capacity	Maximum 15
Communication	RS485/CAN/RS232
Weight (lbs/kg) (Approx.)	278/126
Physical Dimensions (inches/mm) (W*D*H)	22*7.8*31.5/560*200*800 (±2) (Footed glass is not included)
Level of Protection	IP65



## 2.3 Light And Button

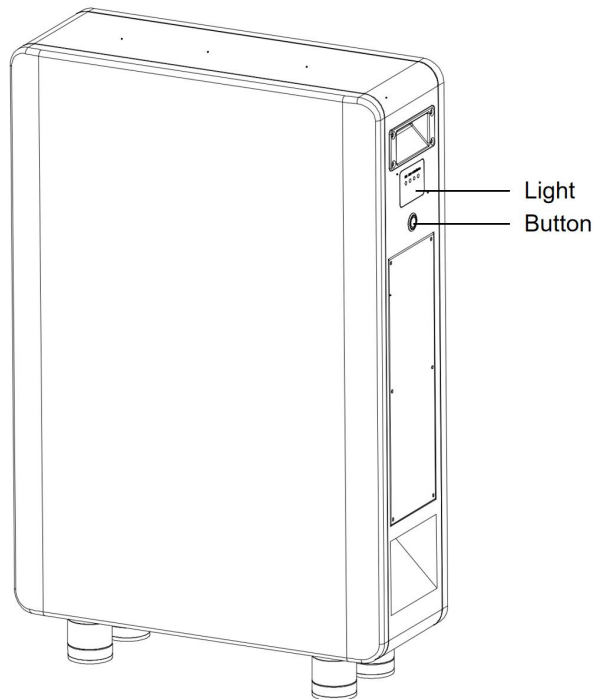

### 2.3.1 Light

The light are used to display current state.

The lights are located on the right side of device.

No.	Item	Specification
1	RUN(Green)	Device shut down:Power off
		Device disconnect router:Always on
		Device has connected router:0.5s on,0.5s off
		Device has connected Renon Cloud Platform:0.5s on,1.5s off
2	Alarm(Yellow)	No alarm or shut down:Power off
		Alarm:Always on
3	Fault(Red)	No protection or fault:Power off
		Protective firing:0.5s on,0.5s off
		Fault triggering:Always on
4	Status(Blue)	Standing:Always on
		Charge: 0.5s on,0.5s off
		Discharge:0.5s on,1.5s off
		Shut down:Power off

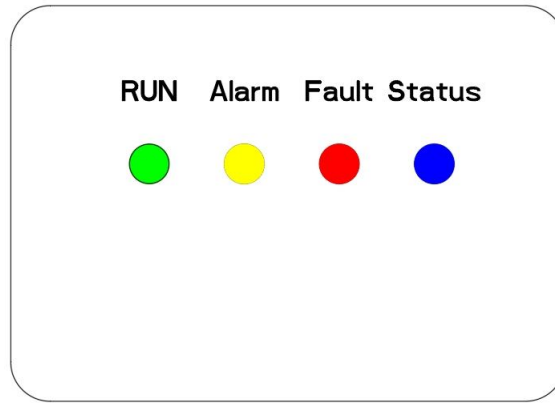

### 2.3.2 Button

The switch is used to power-on/power-off the device.  
The button is located in right corner of device.

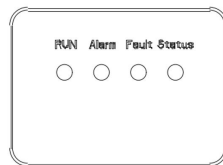



## 2.4 Interface Information

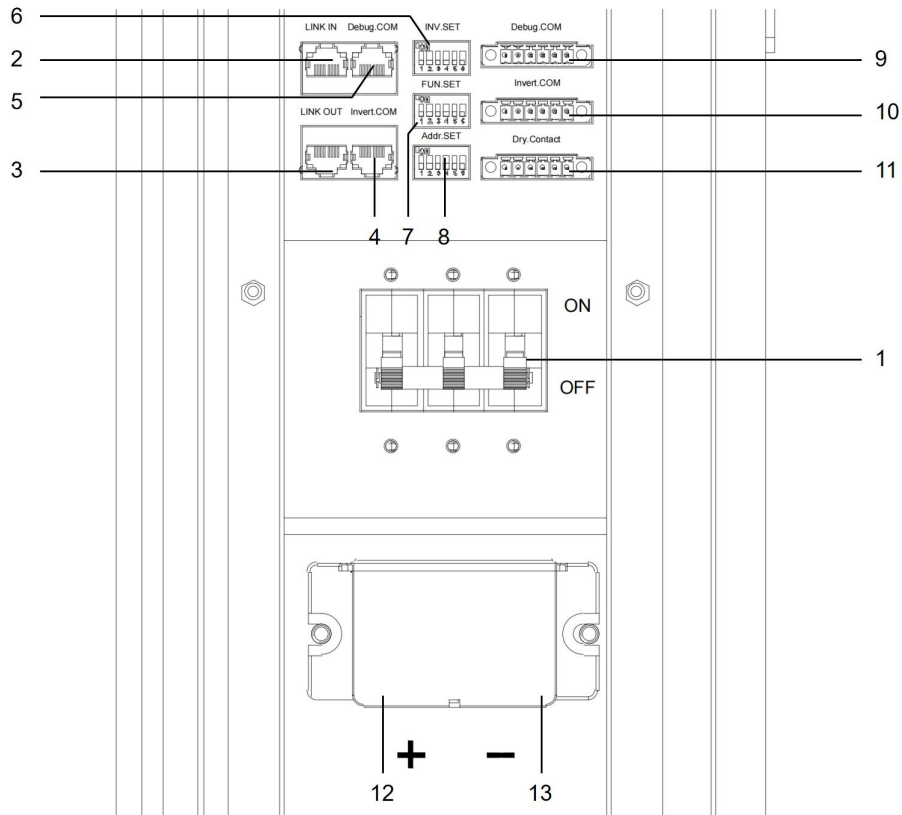

Figure 1.4.1 Battery ports

No.	Instructions	No.	Instructions
1	On/Off	8	Address Dial Switch
2	Link-in Parallel Communication Port	9	Debug Port(connector)
3	Link-out Parallel Communication Port	10	Inverter Communication Port (connector)
4	Inverter Communication Port (RJ45)	11	Dry Contact & GPIO Port
5	Debug Port(RJ45)	12	Power Positive
6	Inverter Dial Switch	13	Power Negative
7	Function Dial Switch		

### 2.4.1 On/Off

The power button is at the bottom of the left side of the battery, press it once to power on the battery, and press it again to power off.

On/Off is connected with inverter terminal box as the below. (Please check



“Connection of Cable and Power” as below in detail)

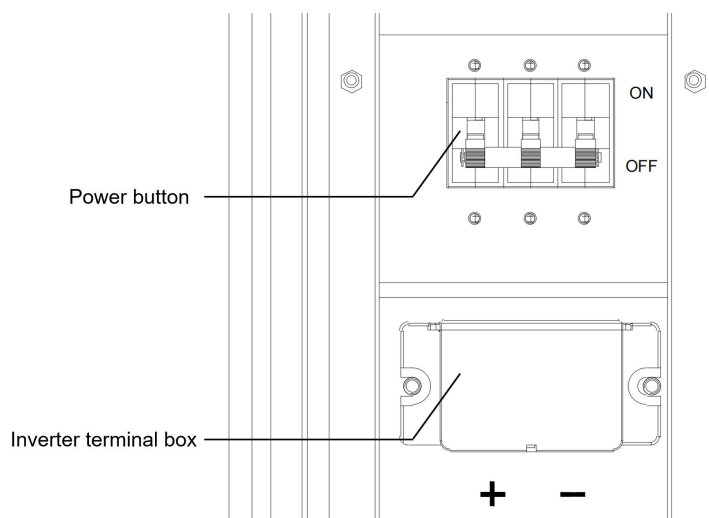

Figure 2.4.1 On/Off introduction

## 2.4.2 Link-in Parallel Communication Port

Terminal type: RJ45

Usage: communicate with the last battery when parallel used.

Port definitions	RJ45 Pin	Function
	1	BMS_CAN1L
	2	BMS_CAN1H
	3	BMS_CC_GND
	4	BMS_CC_GND
	5	BMS_PW_IN1
	6	BMS_CC_GND
	7	BMS_XUNZIN-
	8	BMS_XUNZIN+

One switch power on and Automatic address configuration functions are disabled by default, contact us for support if you need these functions.

## 2.4.3 Link-out Parallel Communication Port

Terminal type: RJ45

Usage: communicate with the next battery when parallel used.

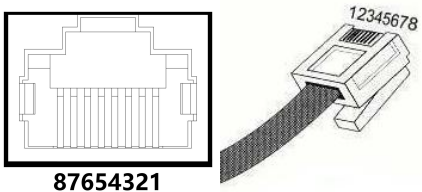

Port definitions	RJ45 Pin	Function
	1	BMS_CAN1L
	2	BMS_CAN1H
	3	BMS_CC_GND
	4	BMS_PW_OUT2
	5	BMS_PW_OUT1
	6	BMS_CC_GND
	7	BMS_XUNZOUT-
	8	BMS_XUNZOUT+

### 2.4.4 Inverter Communication Port (RJ45)

Terminal type: RJ45

Usage: communicate with inverter.

Before connect inverter with battery by communication cable, users need to check its cable sequence at first. Check the manual of inverter for definition of inverter side. Definition of battery side as below:

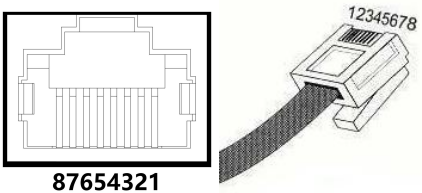
Port definitions	RJ45 Pin	Function
	1	Inverter.RS485-B
	2	Inverter.RS485-A
	3	Inverter.RS485-GND
	4	WAKEUP +
	5	WAKEUP -
	6	Inverter.RS485-GND
	7	Inverter.CANH
	8	Inverter.CANL

### 2.4.5 Debug Port

Terminal type: RJ45

Usage: debug port of the system which used by technician only.



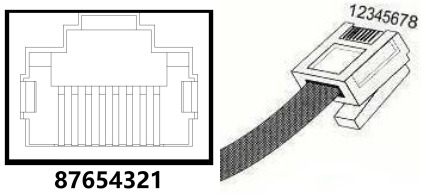

Port definitions	RJ45 Pin	Function
	1	BMS_CAN1L
	2	BMS_CAN1H
	3	BMS_RS232_RX
	4	BMS_CC_GND
	5	BMS_CC_GND
	6	BMS_RS232_TX
	7	IN_CANL
	8	IN_CANH

### 2.4.6 Inverter Dial Switch













Code 0~26 of this Dial Switch are used to match which brand of inverter is using.

(Please refer to Inverter Matching Guide, download from our website:

<https://www.renonpower.com/datasheet.html>

Open the website and select Xcellent Plus, and download the Inverter Matching Guide.)

The definitions of code 0 ~ 26 are shown as below table.

Code	Dial Switch Position	Brand	Logo
0		RENON	
1		(Reserved)	
2		Schneider Gateway	
3		Sol-Ark	
4		Solis_LV	
6		Studer_Xtender	
7		Victron_color control	



8		SMA_LV	
9		Sermatec_LV	
10		Sofar_LV	
11		DEYE	
12		Growatt_SPF	
13		Growatt_SPH&SPA	
14		Must	
15		MEGAREVO	
16		SAJ	
17		Aiswei	
18		Phocos	
22		Voltronic Power	
24		Afore	
25		Lux Power	
26		CHISAGE ESS	

Code 63 is used for special function, defined as below:

Code	Dial Code Switch Position	Definition
------	---------------------------	------------



63		The battery enters WiFi configuration mode, see chapter 3.7 for more information.
----	---	---

### 2.4.7 Function Dial Switch







The dial switch settings for a single are as below:



Single device	#1	#2	#3	#4	#5	#6
Device FUN.SET dial code	1	0	0	0	0	0

### 2.4.8 Address Dial Switch

- 1) Use this Dial Switch to set the address of each battery and then turn on to activate the system when it needs to be in parallel with other battery units.
- 2) When the system only has one battery set, dial the address to 1.
- 3) When the system used in parallel mode, set the address start from 1 and increased by the number of battery units in order to communicate with other battery.
- 4) Only the battery with address of 1 is able to communicate with the inverter.
- 5) The illustration of dialing as shown below:

Code	Dial Switch Position	Definition
1		Set as battery 1 (communicate with inverter by this battery)
2		Set as battery 2
3		Set as battery 3
4		Set as battery 4
5		Set as battery 5
6		Set as battery 6



7		Set as battery 7
8		Set as battery 8
9		Set as battery 9
10		Set as battery 10
11		Set as battery 11
12		Set as battery 12
13		Set as battery 13
14		Set as battery 14
15		Set as battery 15

### 2.4.9 Debug Port (connector)

Terminal type: 6-Pin terminal block

Usage: debug port of the system which used by technician only..

Defined as below:

6pin Terminal	Pin	Usage
	1	BMS_CAN1H
	2	BMS_CAN1L
	3	IN_CANH
	4	IN_CANL
	5	GND
	6	BMS_POWER

### 2.4.10 Inverter Communication Port (connector)

Terminal type: 6-Pin terminal block

Usage: reserved for direct connection with inverter, same function as the RJ45 port (chapter " **Inverter Communication Port (RJ45)**"), only one of these two need to be used, leave it open if not used.

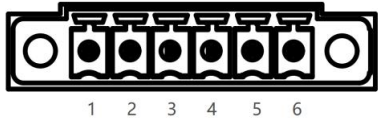

Defined as below:

6pin Terminal	Pin	Usage
	1	RS485_2B
	2	RS485_2A
	3	COM_SGND
	4	CAN2L
	5	CAN2H
	6	COM_SGND

### 2.4.11 Dry Contact & GPIO Port

Terminal type: 6-Pin terminal block

This is for General-purpose input & output (GPIO) which reserved for future communication and used for an uncommitted digital signal pin on an integrated circuit or electronic circuit (e.g. MCUs/MPUs ) board which may be used as an input or output, or both, and is controllable by software.

Defined as below:

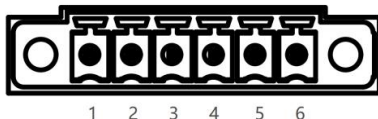
6pin Terminal	Pin	Usage
	1	BMS_NO1
	2	BMS_COM1
	3	BMS_NO2
	4	BMS_COM2
	5	WAKEUP +
	6	WAKEUP -

### 2.4.12 Power Positive

Terminal type: Terminal for 70 mm<sup>2</sup> power cable

Usage: connect to inverter’s positive terminal.

Note:Individual crossing port.

### 2.4.13 Power Negative

Terminal type: Terminal for 70 mm<sup>2</sup> power cable

Usage: connect to inverter’s negative terminal.

Note:Individual crossing port.



## 3 Installation and Usage

### 3.1 Safe Handling Guide

#### 3.1.1 Familiar with the product

Be careful when unpacking the system. The product is heavy. Don't lift them with a pole. The weight of the modules can be found in the chapter "Specifications".

#### 3.1.2 Precautions before installation

Before installation, be sure to read the contents in chapter "Safety Precautions", which is related to the operation safety of installation personnel, please pay attention to it.

#### 3.1.3 Tools

The following tools are required to install the product:



Screwdriver

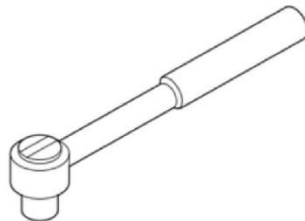

Torque Wrench

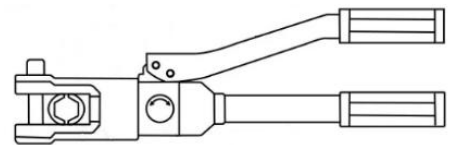

Hydraulic pliers



Drill



Level Ruler

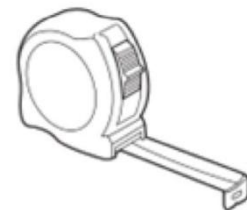

Tapeline

Use properly insulated tools to prevent accidental electric shock or short circuits. If insulated tools are not available, cover the entire exposed metal surfaces of the available tools, except their tips, with electrical tape.

#### 3.1.4 Safety gear

It is recommended to wear the following safety gear when dealing with the



product:



Insulated gloves

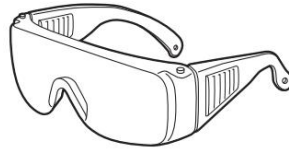

Safety goggles



Safety shoes

### 3.2 System Premeasurement

The battery required adequate clearance for installation, cabling, and airflow. The minimum clearance for system configuration is given below. The cable connecting between battery pack and inverter should be in accordance with the installation guide manual of the inverter.

### 3.3 Installation location

Make sure that the installation location meets the following conditions:











- The surface of the wall is smooth and perpendicular to the ground, which can bear the weight.
- The area is completely water proof.
- The area shall avoid direct sunlight.
- There are no flammable or explosive materials.
- The distance from heat source is more than 80inch(2m).
- The ambient temperature is within the range from 32°F(0°C) to 95°F(35°C).
- The humidity is maintained at a constant level.
- There is minimal dust and dirt in the area.
- Avoid installation in an area confined or with high salinity.
- Do not install outside directly.
- Do not place in an area accessible to children or pets.



### 3.4 Package items





After receiving the product, please unpack the boxes, and check product and packing list first, if product is damaged or lack of parts, please contact with the local retailer.

Here is the Xcellent Plus Packing List:

No.	Item	Specification	Qty	Usage	Diagram
1	Xcellent Plus	R-XC016161(-H)	1	Battery	
2	Mounting Panel	15*3*0.5(inches)/508*215*20(mm)	1	Mounting battery on the wall	
3	Embedded Screw	M8*80	6	Fix battery on the wall	
4	Embedded Screw	M6*12	16	Fix truckle on the trundle	
5	Embedded Screw	M5*12	1	Fix mounting panel on the wall and connect grounding	
6	Power Cable-Positive (customizable)	SC70-8 to SC70-8, 60inches (1.5m), red	1	Connect positive of battery to inverter	
7	Power Cable-Negative (customizable)	SC70-8 to SC70-8, 60inches (1.5m), black	1	Connect negative of battery to inverter	
8	Communication Cable	CAT6,16awg, 80inches (2m),black	1	Communication for parallel	
9	Universal Wheel	2.5 inches	2	Fix truckle on the bottom	
10	Directional Wheel	2.5 inches	2	Fix truckle on the bottom	



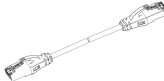

11	Footed glass	∅ 60-M10-80	4	Connect panel bottom	
12	Pin order select box (optional)	3.3*1.0*0.9inches /85*26*22mm	1	Set the pin order of the communication cable of battery and inverter, cooperate with 2 standard network cable	
13	Inverter Communication Cable (Optional)	Standard RJ45 network cable, 1m	2	Connect the communication pole of battery and inverter	
14	User manual	Xcellent Plus	1	User manual	

### 3.5 Installation

The location of the installation must be uninhabitable.

Method 1: On the wall

- 1) Make sure whether the wall can support the weight of the device.
- 2) Find a appropriate installation position as the diagram below, drill the mounting screws, and install the bracket on the wall.

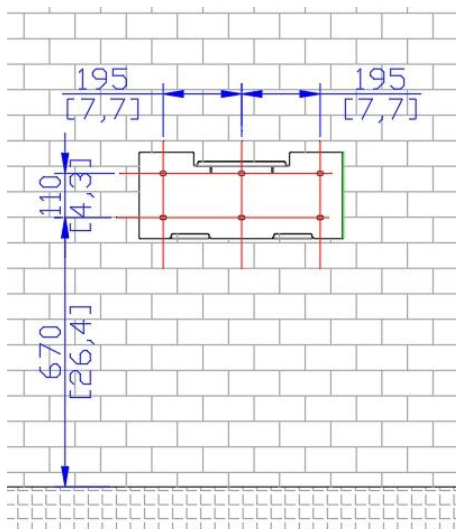

Figure 3.5.1 Mounting panel dimension on the wall

- 3) Fix the product on the bracket to ensure that the wall hanging is stable and perpendicular to the wall.

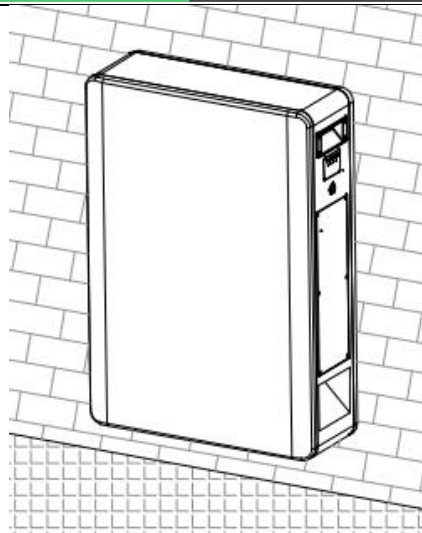

Figure 3.5.2 Put Xcellent Plus on the mounting panel

- 4) Secure the screw to grounding cable hole and grounding, using M5 screws to secure the device and bracket.
- 5) Please plug the protective ring of the outlet line with fireproof mud after installing.

### Method 2: On the ground

- 1) Make sure whether the wall can support the weight of the device.
- 2) Find an appropriate installation position as the picture below, drill the mounting screws, and install the bracket on the wall.

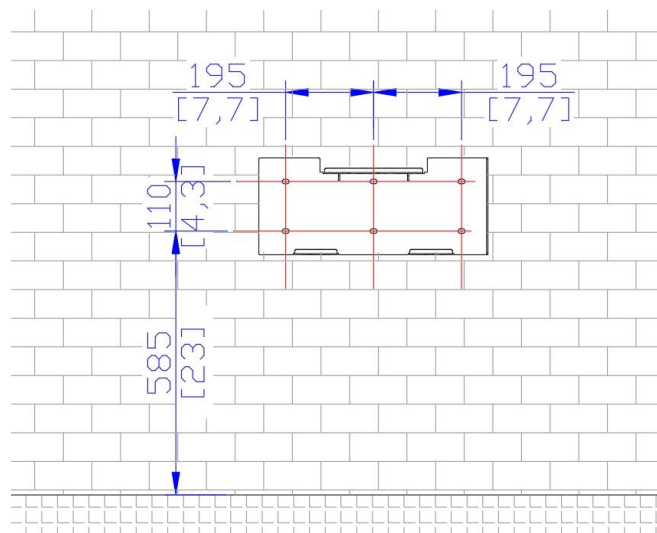

Figure 3.5.3 Device grounding installation dimension

- 3) Fix the product on the bracket to ensure that the wall hanging is stable and perpendicular to the wall.

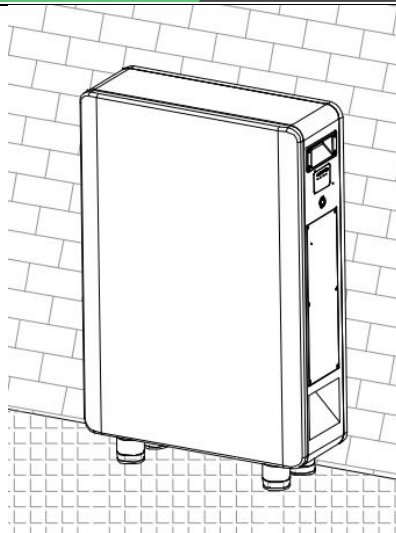

Figure 3.5.4 Fix footed glass on the ground

- 4) Secure the screw to grounding cable hole and grounding, using M5 screws to secure the device and bracket.
- 5) Rotate the footed glass to the right and mount it to the bottom plate.
- 6) Adjust the appropriate position as the following diagram.
- 7) Please plug the protective ring of the outlet line with fireproof mud after installing.

### Method 3: Removable

- 1) Make sure whether the wall can support the weight of the device.
- 2) Find a appropriate installation position as the diagram below, drill the mounting screws, and install the bracket on the wall.

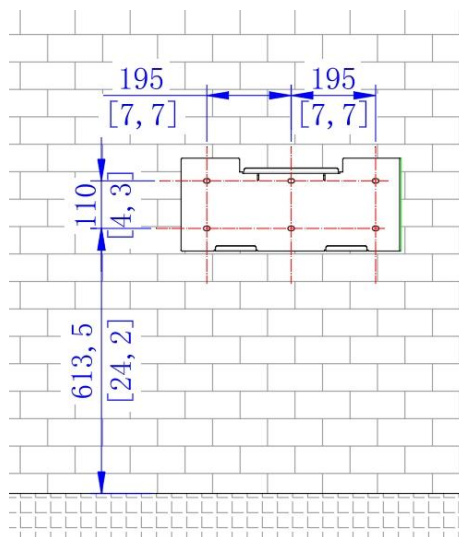

Figure 3.5.5 Device standing installation dimension.



- 3) Move the device in a appropriate position.Do not back and forth when you move the device for prevent device dumping.

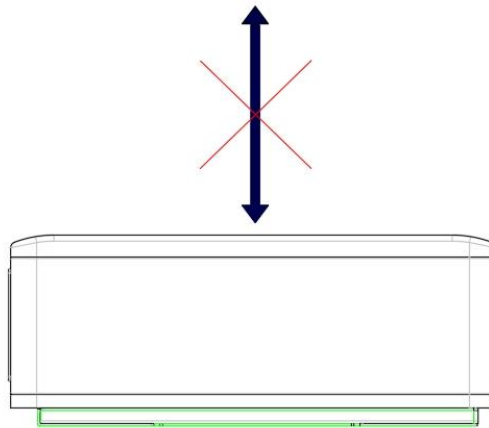

Figure 3.5.7 Device moving direction

- 4) Fix the product on the bracket to ensure that the wall hanging is stable and perpendicular to the wall.

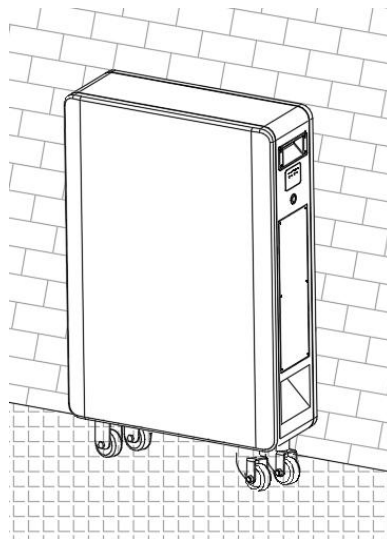
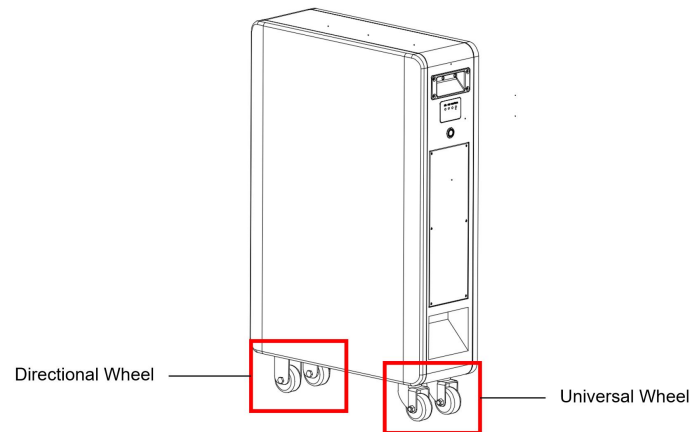

Figure 3.5.6 Device standing

- 5) Secure the screw to grounding cable hole and grounding,using M5 screws to secure the device and bracket.
- 6) What you need to pay attention is that the left is the directional wheel and the right is the universal wheel.
- 7) Please plug the protective ring of the outlet line with fireproof mud after installing.



*Figure 3.5.7 Installation location*

### 3.6 Connection of Cable and Power

- 1) Remove the side panel.

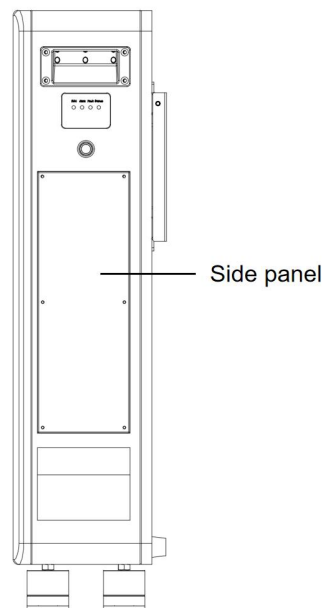

*Figure 3.6.1 Side view of Xcellent Plus*

- 2) Set the address dial code (**Addr. SET**) of battery as code 1, set its function dial code (**Function SET**) as code 4 and set its inverter dial code (**INV. SET**) to the corresponding inverter's code.
- 3) Turn off the system and then connect the battery positive and negative electrode with the inverter's positive and negative electrode separately.

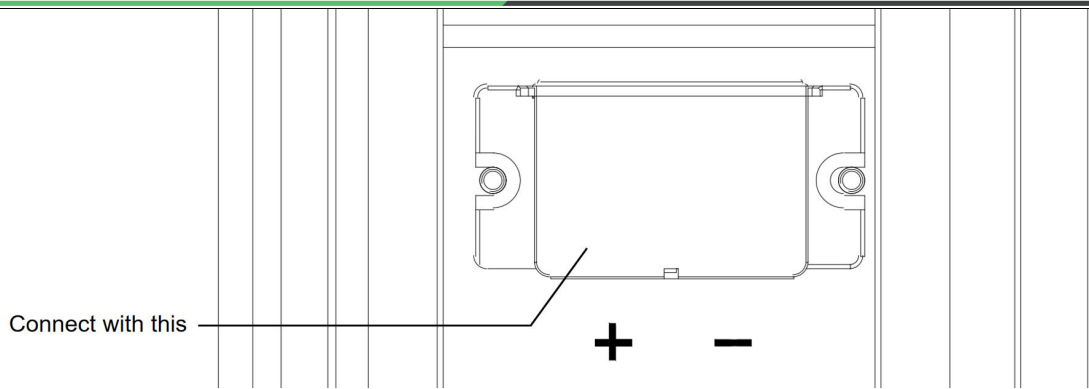

Figure 3.6.2 Power wire connection

- 4) Connect CAN/RS485 wire to the inverter port of the master controller and inverter's CAN/RS485 port.

If you are using the pin order select box, please refer to the table below to set the dial switch, according to the inverter brand. If the inverter brand is not shown in the table, please refer to the inverter manual or consult Renon's engineer.

Dial switch position		Inverter brand	Comm Mode
<p>ANI H L CAN RS485 A B BAT</p>	Schneider_Gateway	CAN	
<p>ANI H L CAN RS485 A B BAT</p>	Sol-Ark	CAN	
<p>ANI H L CAN RS485 A B BAT</p>	Solis	CAN	
<p>ANI H L CAN RS485 A B BAT</p>	Studer	CAN	
<p>ANI H L CAN RS485 A B BAT</p>	Victron	CAN	



	SMA	CAN
	Sermatec	CAN
	Sofar	CAN
	DEYE	CAN
	Growatt_SPF	RS485
	Growatt_SPH&SPA	CAN
	Must	CAN
	MEGAREVO	CAN
	SAJ	CAN
	Aiswei	CAN
	Phocos	RS485



<p>Terminal block diagram for Voltronic Power. It shows two 12-pin terminal blocks. The left block is labeled 'CAN' and has pins H, L, and V. The right block is labeled 'RS485' and has pins A and B. The overall unit is labeled 'BAT'.</p>	Voltronic Power	RS485
<p>Terminal block diagram for Afore. It shows two 12-pin terminal blocks. The left block is labeled 'CAN' and has pins H, L, and V. The right block is labeled 'RS485' and has pins A and B. The overall unit is labeled 'BAT'.</p>	Afore	CAN
<p>Terminal block diagram for Lux Power. It shows two 12-pin terminal blocks. The left block is labeled 'CAN' and has pins H, L, and V. The right block is labeled 'RS485' and has pins A and B. The overall unit is labeled 'BAT'.</p>	Lux Power	CAN
<p>Terminal block diagram for CHISAGE ESS. It shows two 12-pin terminal blocks. The left block is labeled 'CAN' and has pins H, L, and V. The right block is labeled 'RS485' and has pins A and B. The overall unit is labeled 'BAT'.</p>	CHISAGE ESS	CAN

5) Put side panel back and screw it firmly.

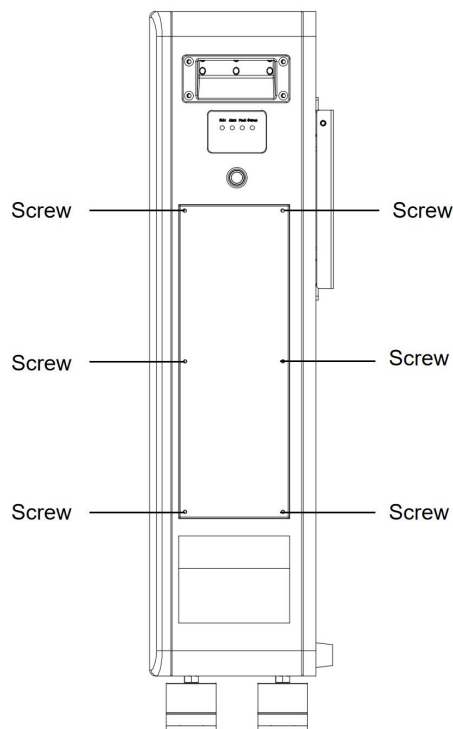
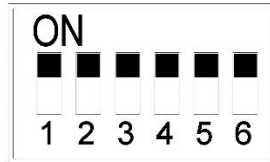

Figure 3.6.4 Mount back the side panel

### 3.7 Wi-Fi Configuration

Set the inverter dial code (**INV SET**) to 63(111111) as shown below before Wi-Fi configuration.





- 1) Download and install RENON APP from Google or Apple Store by searching Renon Smart.

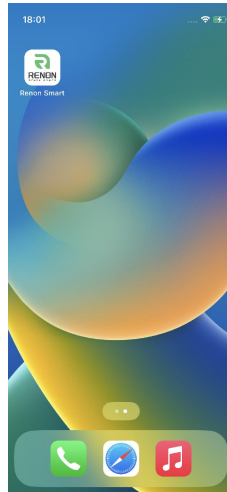

*Figure 3.7.1. Install RENON APP*

- 2) You may acquire the Register Code from your installer for new account registration. If you already had an account (Installer Company level, Installer level and End User level) , you may use it to login the APP directly otherwise you need to create an account.

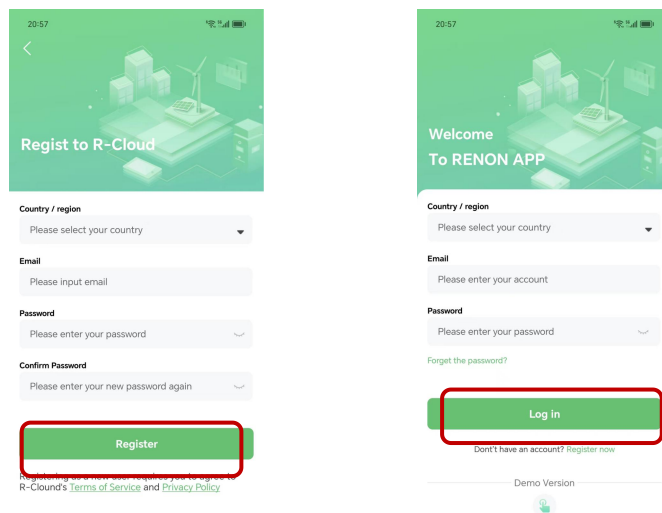

*Figure 3.7.2. Start the APP & Create an account & Sign in*

- 3) Turn to the page Mine, click the Network configuration, then click Bluetooth Model, and following by the instruction of network setting for WIFI configuration.

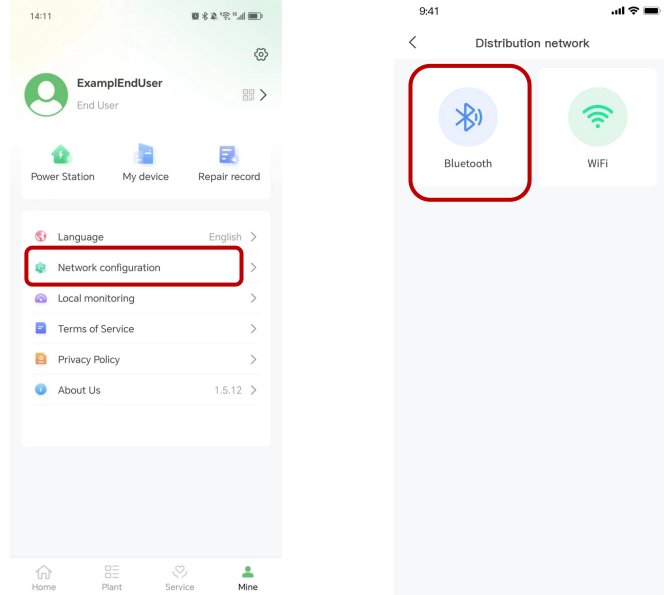

*Figure 3.7.3. Bluetooth Network Setting*

- 4) Connect your mobile phone to the Bluetooth from the master controller which SSID is same as controller's serial number (SN).

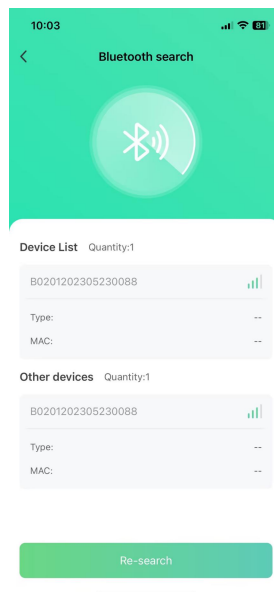

*Figure 3.7.4. Connect Battery Bluetooth*

- 5) Enter the SSID and password of your private WI-FI for connecting master controller to your private WI-FI. Make sure the Run light on battery will blinking. When the Run light is blinking very slowly, it means that the Battery has connected to the Cloud successfully.

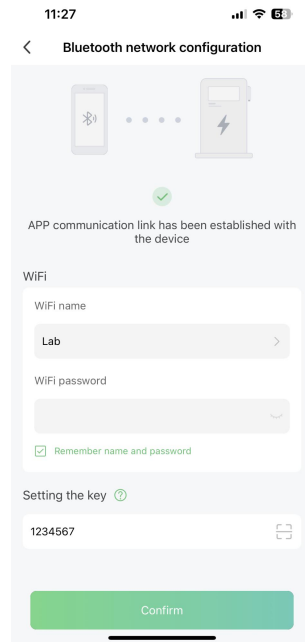

Figure 3.7.5. Connecting Private WIFI

- 6) If you can not find the Bluetooth from the battery. Please go back to Distribution network interface, and click WIFI model. And following by the instruction of network setting for WIFI configuration.

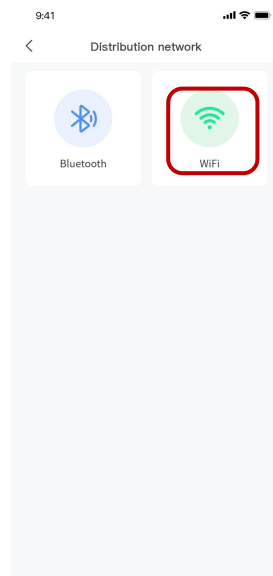

Figure 3.6.6. WIFI Network Setting

- 7) Please input the serial number of the device you want to WIFI configuration and input the device Verification code.

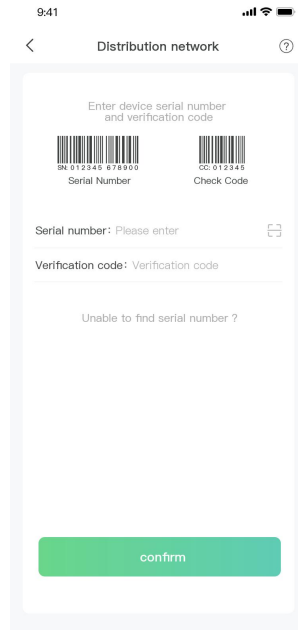

Figure 3.7.7. Input Device Serial Number and Verification Code

How to find the device verification code?

Step1: Click my device at page Mine.

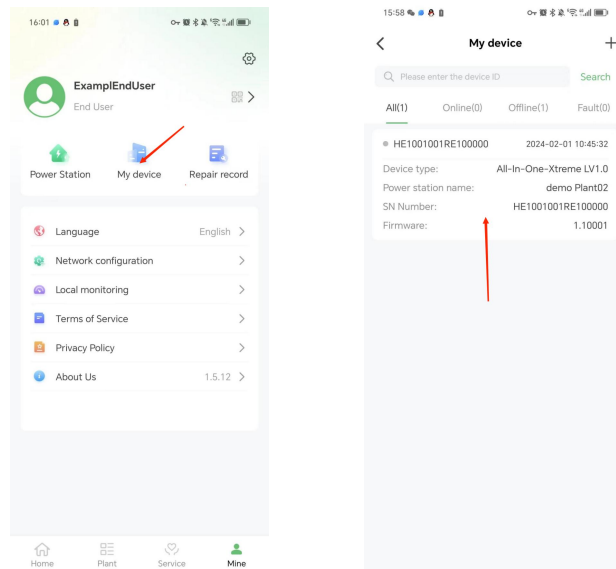

Figure 3.7.8. Find the Device

Step2: Click the device and click the "details" in the upper right corner of the interface, and then click "Device key" . It will show the verification code .For example, "123456" shown in the picture.

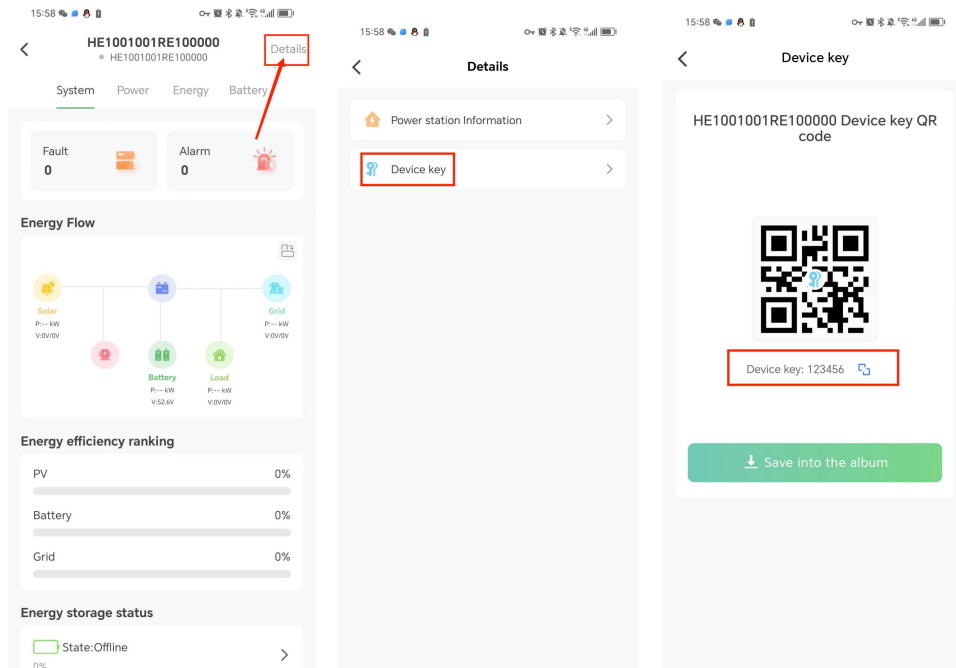

Figure 3.7.9. Find the Device Key

- 8) Connect your mobile phone to the WI-FI hotspot from the battery which SSID is same as battery's serial number (SN) and the password is 12345678.
- 9) Enter the SSID and password of your private WI-FI for connecting master controller to your private WI-FI. When the Run light is blinking very slowly, it means that the Battery has connected to the Cloud successfully.

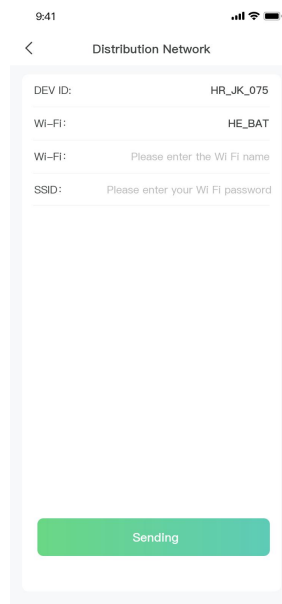

Figure 3.7.10. Connecting Private WIFI

- 10) Ask your installer to assign all your products to your account.



11) Turn to main page of the APP, create a plant, and set a power station name, power station type, grid price configuration,superiors view and power station address for it.

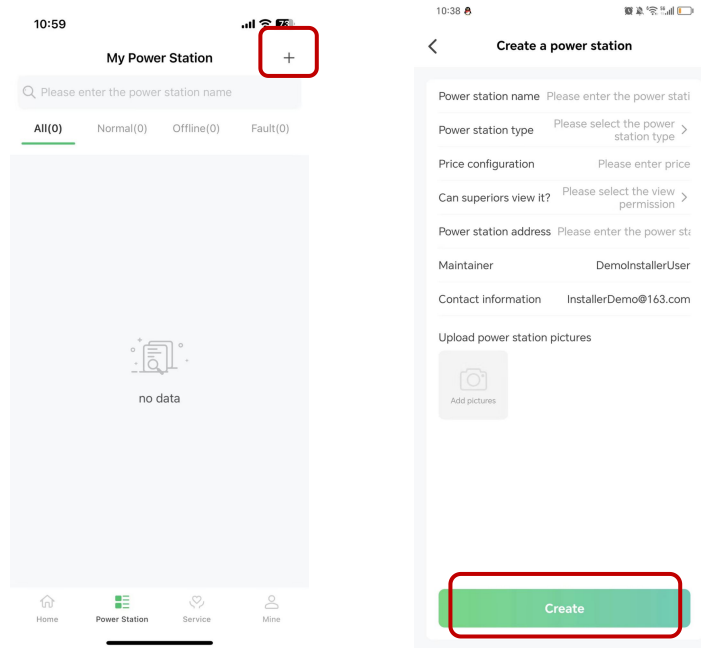

Figure 3.7.11. Create A New Plant

12) Click the Add device button to add the device to your plant and all your products will show up as their SN, select proper products and confirm.

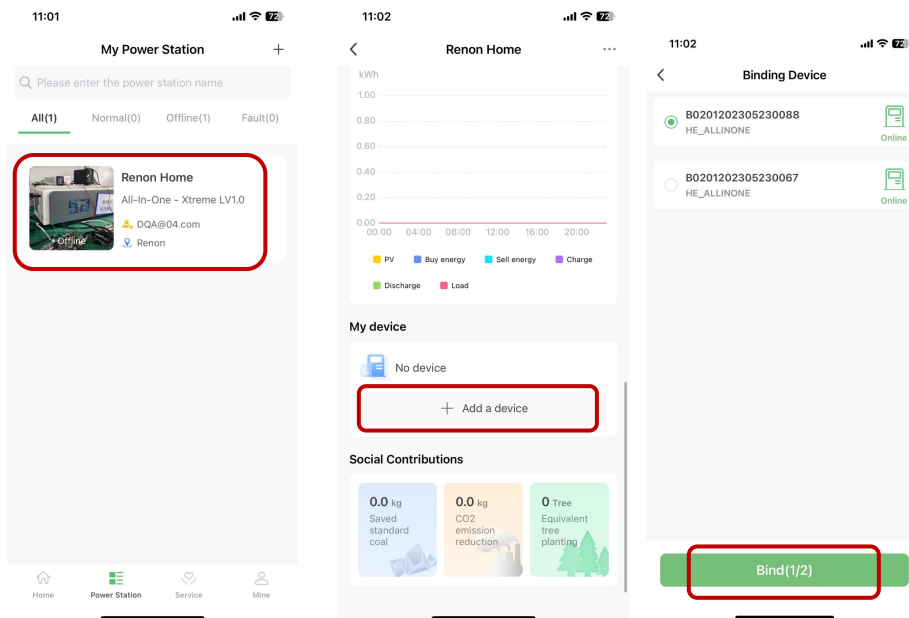

Figure 3.7.12. Manage Your Plant & Confirm Your Products

13) Now you can manage your products in the APP, and you can also manage them in Website, ask your installer for the site URL.

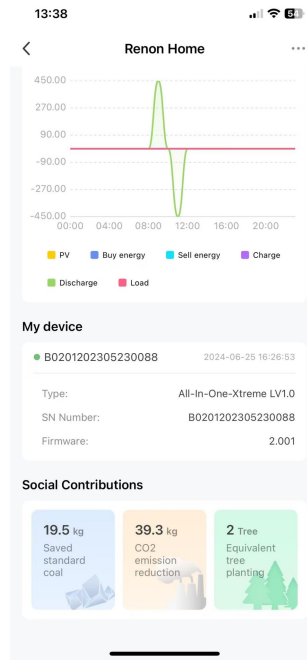

Figure 3.7.13. Manage Your Products

14) After the product is connected to Wi-Fi, the running status, real-time power, daily power consumption and cumulative power of the product can be monitored in real time on the network platform or mobile APP. It can also be used to configure parameters

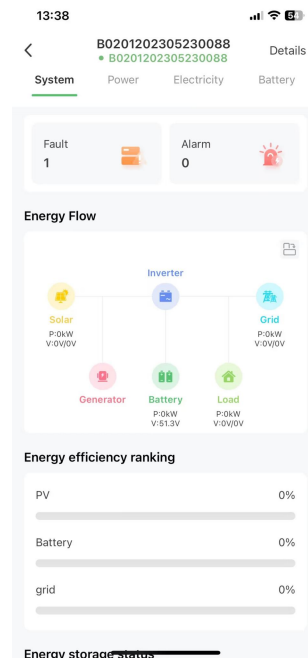

Figure 3.7.14. Monitoring Device

Set the inverter dial code to match the inverter brand after Wi-Fi configuration finished (Please refer to the chapter **2.3.3 Inverter Dial Switch**).



### 3.8 Parallel connection (Optional)

If user needs to set up a system more than one Xcellent, user can set up a parallel system.

- 1) Each Xcellent's address dial code should be set as 1,2, 3... in order. Set the inverter dial code of the battery with address of 1 to the corresponding inverter's code, please refer to chapter of inverter dial code.
- 2) Set the Function dial code (**FUN.SET**) of the minimum and maximum address as code 1 when parallel.



When 3 devices in parallel	#1	#2	#3	#4	#5	#6
The first device	1	0	0	0	0	0
The second device	0	0	0	0	0	0
The third device	1	0	0	0	0	0

- 3) Use parallel communication lines to connect Link-out of battery 1 to Link-in of battery 2, and Link-out of battery 2 to Link-in of battery 3, and so on.
- 4) Connect power cable of each battery and inverter directly to the busbar. Make sure the busbar can stand for the maximum current of the system. Connect INV.COM of battery with code 1 to inverter's BMS port, check the inverter manual for knowing the signal order of its BMS port.

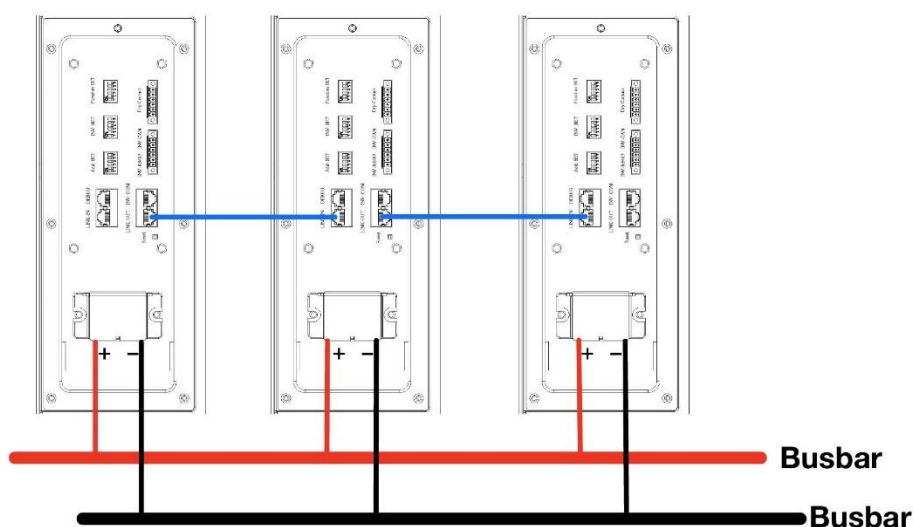

- 5) Turn on all batteries. Check whether errors or warning occurs on the screen of batteries and the inverter.





## 4 Troubleshooting & Maintenance

### 4.1 Regular maintenance

- 1) Check the battery modules every 3 months to verify whether there are damages.
- 2) Check the battery modules every 3 months to verify whether the operating parameter is normal or there is no abnormal heating.
- 3) Fully charge and discharge the battery system every 3 months.
- 4) Clean the battery modules with a dry rag once a month.

### 4.2 Troubleshooting

The table given below also helps user to address the failure accurately.

Phenomenon	Possible Causes of Failure
Unable to turn on the battery	<ol style="list-style-type: none"> <li>1. Try to charge the battery by the activation charging function of the inverter when power is on.</li> </ol>
No output after power on.	<ol style="list-style-type: none"> <li>1. Make sure the address dial code setting is correct, refer to the chapter of address dial code.</li> <li>2. Make sure SOC is not 0% otherwise charge battery please.</li> </ol>



<p>Unable to communicate with inverter</p>	<ol style="list-style-type: none"> <li>1. Make sure the connection of communication cable and power cable is correct, refer to the chapter of connection of cable and power.</li> <li>2. Make sure the address dial code of the master controller connected to inverter is 1.</li> <li>3. Make sure the inverter dial code of the master controller connected to inverter is correct, refer to the chapter of inverter dial code.</li> <li>4. If you are using a pin order select box, please verify that the dialing switch is configured correctly.</li> </ol>
<p>Unable to be charged by inverter</p>	<ol style="list-style-type: none"> <li>1. Make sure power cable connection is correct.</li> <li>2. Check whether inverter has faults.</li> <li>3. Check whether grid or PV is available.</li> <li>4. Make sure Time of Use of the inverter setting is correct.</li> <li>5. Make sure charging voltage and charging current setting of the inverter match the parameters of the battery.</li> <li>6. Check the battery low or high temperature protection alarm.</li> <li>7. Check the over current protection alarm.</li> <li>8. Make sure the SOC value is below 96% (default value).</li> </ol>
<p>Unable to discharge while SOC is not zero.</p>	<ol style="list-style-type: none"> <li>1. Make sure the connection of cables is correct and circuit breaker is ON.</li> <li>2. Check whether inverter has faults.</li> <li>3. Make sure the inverter setting is not back up mode.</li> <li>4. Check whether SOC is lower than the shutdown value of the inverter.</li> <li>5. Check the battery low or high temperature protection alarm.</li> <li>6. Check the over current protection alarm.</li> </ol>



<p>Error or Alarm shown on the screen</p>	<ol style="list-style-type: none"> <li>1. Check the battery refer to the definition of the error or warning codes. If cannot solve the problem, please contact the installer.</li> </ol>
<p>Unable to find the battery on the APP &amp; the cloud</p>	<ol style="list-style-type: none"> <li>1. Make sure the antenna is screwed properly.</li> <li>2. Make sure the WIFI configuration is correct.</li> <li>3. Make sure the SSID &amp; PASSWORD of your private WIFI is correct, please enter information case-sensitively without space.</li> <li>1. Make sure the frequency of the WIFI connected to the product is (2.4GHz or 2.4GHz / 5GHz dual frequency integration).</li> <li>4. Make sure the WIFI signal is strong enough.</li> <li>5. Make sure WIFI is working.</li> <li>6. Make sure installer is distributed your products on user's account.</li> <li>7. Try to restart the WIFI router.</li> </ol>

### 4.3 Alarm Codes

Code	Warning type	Investigation & troubleshooting
W1	Battery cell undervoltage alarm	<ol style="list-style-type: none"> <li>1. Low voltage level and needs to be charged.</li> </ol>
W2	Charge overcurrent alarm	<ol style="list-style-type: none"> <li>1. Restore to factory setting.</li> <li>2. Make sure the inverter's setting of max current do not excess the max charge current of the battery.</li> </ol>



W3	Discharge overcurrent alarm	1. Make sure the power of load do not exceed the power of battery.
W4	High charge temp alarm	1. Make sure the battery's temperature shown on the inverter or the APP is below 50°C, otherwise turn off the battery till the temperature is below 50°C and then try to charge battery.
W5	High discharge temp alarm	1. Make sure the battery's temperature shown on the inverter or the APP is below 50°C, otherwise turn off the battery till the temperature is below 50°C and then try to discharge battery.
W6	Low charge temp alarm	1. Make sure the battery's temperature shown on the inverter or the APP is above 0°C, otherwise turn off the battery till the temperature is above 0°C and then try to charge battery.
W7	Low discharge temp alarm	1. Make sure the battery's temperature shown on the inverter or the APP is above -20°C, otherwise turn off the battery till the temperature is above -20°C and then try to charge battery.
W8	High ambient temp alarm	1. Make sure the ambient temperature of the battery is below 50°C.
W13	Low total voltage alarm	1. Low voltage level and needs to be charged
W14	Low ambient temp alarm	1. Make sure the ambient temperature of the battery is above -25°C.
W15	High MOS temp alarm	1. Reduce the ambient temperature and restart the battery.
W16	Battery cell overvoltage alarm	1. High voltage level and needs to be discharged.
W17	High total voltage alarm	1. High voltage level and needs to be discharged.



W18	Low SOC alarm	1. Low SOC and needs to be charged.
-----	---------------	-------------------------------------

## 4.4 Error Codes

Code	Error Type	Investigation & troubleshooting
F102	Battery cell fault	1. Restart the battery, and if the error code F102 still remaining or reappear, contact your installer.
F103	NTC fault	1. Restart the battery, and if the error code F103 still remaining or reappear, contact your installer.
F104	Current sensor fault	1. Restart the battery, and if the error code F104 still remaining or reappear, contact your installer.
F106	Short circuit fault	1. Make sure the external connection for both battery and inverters are proper. 1. Disconnect all external connections and restart the battery, and if the error code F106 still remaining or reappear, contact your installer.
F111	Charge MOS fault	1. Restart the battery, and if the error code F111 still remaining or reappear, contact your installer.
F112	Discharge MOS fault	1. Restart the battery, and if the error code F112 still remaining or reappear, contact your installer.
F131	Pack disconnect fault	1. Restart the battery, and if the error code F131 still remaining or reappear, contact your installer.



F132	EMS SN is empty	2. Restart the battery, and if the error code F132 still remaining or reappear, contact your installer.
F135	Pack SN is empty	1. Restart the battery, and if the error code F135 still remaining or reappear, contact your installer.

## 4.5 Protection Codes

Code	Error Type	Investigation & troubleshooting
P1	Battery cell undervoltage protection	1. Low voltage level and needs to be charged.
P2	Overcurrent charge protection	1. Restore to factory setting. 2. Make sure the inverter's setting of max current do not excess the max charge current of the battery.
P3	Overcurrent discharge protection	1. Make sure the power of load do not exceed the power of battery.
P4	High charge temp protection	1. Make sure the battery's temperature shown on the inverter or the APP is below 52°C, otherwise turn off the battery till the temperature is below 52°C and then try to charge battery.
P5	High discharge temp protection	1. Make sure the battery's temperature shown on the inverter or the APP is below 52°C, otherwise turn off the battery till the temperature is below 52°C and then try to discharge battery.
P6	Low charge temp protection	1. Make sure the battery's temperature shown on the inverter or the APP is above 0°C, otherwise turn off the battery till the temperature is above 0°C and then try to charge battery.
P7	Low discharge temp protection	1. Make sure the battery's temperature shown on the inverter or the APP is above -20°C, otherwise turn off the battery till the temperature is above -20°C and then try to charge battery.



P8	High ambient temp protection	1. Make sure the ambient temperature of the battery is below 50°C.
P13	Low total voltage protection	1. Low voltage level and needs to be charged.
P14	Low ambient temp protection	1. Make sure the ambient temperature of the battery is above -25°C.
P15	High MOS temp protection	1. Reduce the ambient temperature and restart the battery.
P16	Battery cell overvoltage protection	1. High voltage level and needs to be discharged.
P17	High total voltage protection	1. High voltage level and needs to be discharged.